



Revolving Warning Beacons

Girofari e lampeggianti

Catalogue

ITALIAN DESIGN
QUALITY STANDARD
CUSTOMIZED SOLUTIONS
ERGONOMIC STUDY
SAFETY APPROACH



IMEL Division

GIROFARO MAGNETICO A LED BATTERIA 12-24V

GYROPHARE A LED AVEC BATTERIE 12-24V
 RECHARGEABLE LED BEACON 12-24V
 WIEDERAUFLADBARE LED BEACON 12-24V
 LUZ GIRATORIA LED CON BATERIA 12-24V

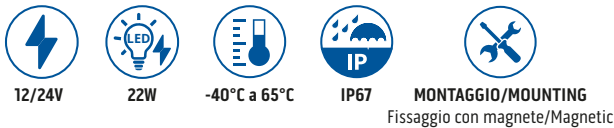
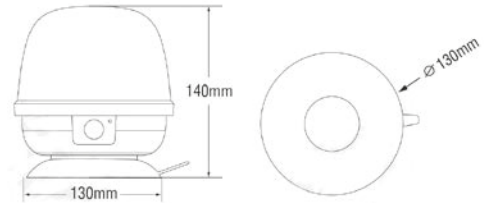

RICAMBI/ SPARE PARTS

Art./Ref.	Descrizione
66009	Cavo con spina a ricambio
66008	Spina alimentazione 100-240V a ricambio

Art./Ref.	Colore/Color	Descrizione/Description	Configurazioni/Configurations	Note/Notes
66010	Ambra Amber	Durata batteria 6 ore, tempo di ricarica 4 ore/Discharging time 6 hours, charging time 4 hours	3 modalità flash e 4 modalità di rotazione	ECE-R10, ECE-R65 * se il girofaro è collegato all'alimentatore/ ECE-R10, ECE-R65 * must be plugged into the cigarette lighter

GIROFARO LED A BATTERIA CON TELECOMANDO 12/24V

GYROPHARE A LED AVEC BATTERIE ET TÉLÉCOMMANDE 12 / 24V
 RECHARGEABLE LED BEACON WITH REMOTE CONTROLLER
 WIEDERAUFLADBARE LED-BLITZLEUCHTE MIT FERNBEDIENUNG 12/24V
 LUZ GIRATORIA LED CON BATERIA Y CON MANDO A DISTANCIA 12-24V

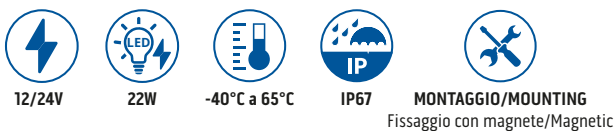
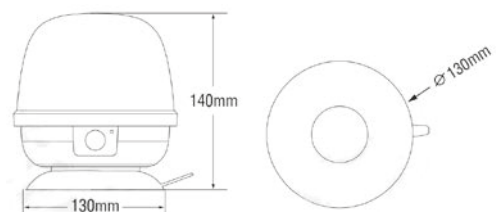

RICAMBI/ SPARE PARTS

Art./Ref.	Descrizione
66009	Cavo con spina a ricambio
66008	Spina alimentazione 100-240V a ricambio
66149	Telecomando a ricambio

Art./Ref.	Colore/Color	Descrizione/Description	Configurazioni/Configurations	Note/Notes
66150	Ambra Amber	Durata batteria 6 ore, tempo di ricarica 4 ore/Discharging time 6 hours, charging time 4 hours	3 modalità flash e 4 modalità di rotazione	ECE-R10, ECE-R65 * se il girofaro è collegato all'alimentatore/ ECE-R10, ECE-R65 * must be plugged into the cigarette lighter

GIROFARO LED A BATTERIA 12-24V

GYROPHARE A LED AVEC BATTERIE 12-24V
 RECHARGEABLE LED BEACON 12-24V
 WIEDERAUFLADBARE LED BEACON 12-24V
 LUZ GIRATORIA LED CON BATERIA 12-24V

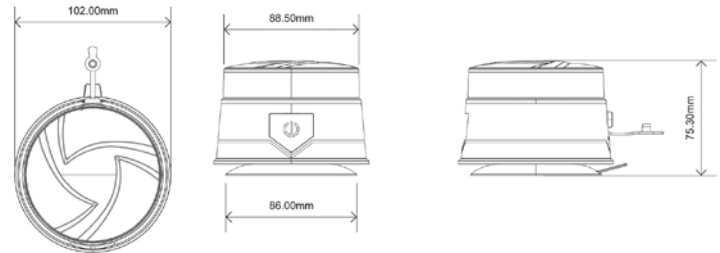

12/24V
 19W
 -40°C a 65°C
 IP67
 MONTAGGIO/MOUNTING
 Fissaggio con magnete/Magnetic

RICAMBI/ SPARE PARTS

Art./Ref.	Descrizione
66009	Cavo con spina a ricambio
66008	Spina alimentazione 100-240V a ricambio

Art./Ref.	Ampere/ Ampere	Colore/ Color	Descrizione/ Description	Configurazioni/ Configurations	Note/Notes
68080	0,58A a 24V	Ambr/Amber	Durata della carica della batteria 6,5 ore, tempo di ricarica 4 ore/Discharging time 6,5 hours, charging time 4 hours	3 modalità flash e 4 modalità di rotazione/3 modes flash & 4 modes rotation	ECE-R10, ECE-R65 * se il girofaro è collegato all'alimentatore/ ECE-R10, ECE-R65 * must be plugged into the cigarette lighter

GIROFARO LED A BATTERIA CON TELECOMANDO 12/24V

GYROPHARE A LED AVEC BATTERIE ET TÉLÉCOMMANDE 12/24V
 RECHARGEABLE LED BEACON WITH REMOTE CONTROLLER 12/24V
 WIEDERAUFLADBARE LED-BLITZLEUCHTE MIT FERNBEDIENUNG 12/24V
 LUZ GIRATORIA LED CON BATERIA Y CON MANDO A DISTANCIA 12-24V

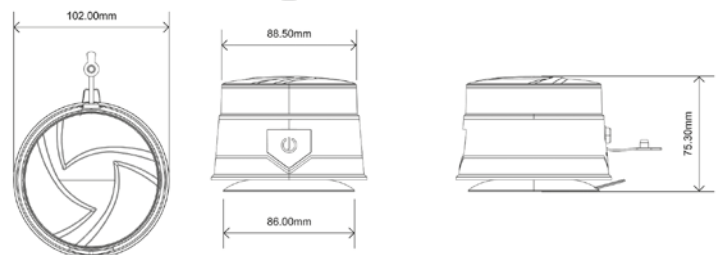

12/24V
 19W
 -40°C a 65°C
 IP67
 MONTAGGIO/MOUNTING
 Fissaggio con magnete/Magnetic

RICAMBI/ SPARE PARTS

Art./Ref.	Descrizione
66009	Cavo con spina a ricambio
66008	Spina alimentazione 100-240V a ricambio
66149	Telecomando a ricambio

Art./Ref.	Ampere/ Ampere	Colore/ Color	Descrizione/ Description	Configurazioni/ Configurations	Note/Notes
68081	0,58A a 24V	Ambr/Amber	Durata della carica della batteria 6,5 ore, tempo di ricarica 4 ore/Discharging time 6,5 hours, charging time 4 hours	3 modalità flash e 4 modalità di rotazione/3 modes flash & 4 modes rotation	ECE-R10, ECE-R65 * se il girofaro è collegato all'alimentatore/ ECE-R10, ECE-R65 * must be plugged into the cigarette lighter

LAMPEGGIANTI A LED 12/24V

GYROPHARE A LED12-24V
LED BEACONS 12/24V
DREHLEUCHTE LED 12-24V
FAROS ROTATIVO12-24V

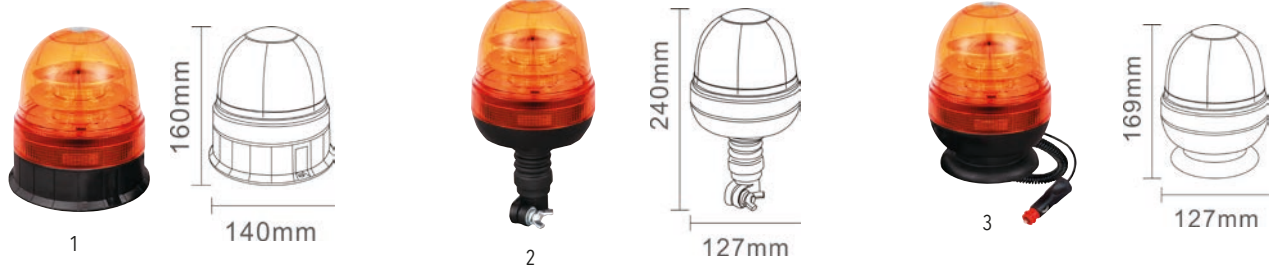

RICAMBI/ SPARE PARTS

Art./Ref.	Descrizione
59114	Calotta serie GEA ambra in policarbonato
04593	Cavo spiralato con spina agricola ON/OFF

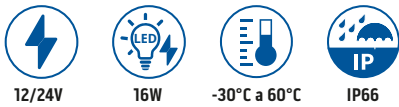

Art./Ref.	Pos.	Descrizione/Description	Configurazioni/Configurations	Colore/Color	Certificazione/Certification
62480	1	Base piana/ 3-Bolt fixing	Tre sistemi di luminosità: rotazione, flash singolo, flash veloce / Pattern: rotation, sigle flash, quick flash	Ambra/Amber	Certificazioni: CE EMC ECE R65, IP66
62481	2	Base flessibile con attacco ad asta/ Flex din	Tre sistemi di luminosità: rotazione, flash singolo, flash veloce / Pattern: rotation, sigle flash, quick flash	Ambra/Amber	Certificazioni: CE EMC ECE R65, IP66
62482	3	Base magnetica/ Magnetic base	Tre sistemi di luminosità: rotazione, flash singolo, flash veloce / Pattern: rotation, sigle flash, quick flash	Ambra/Amber	Certificazioni: CE EMC ECE R65, IP66
68695	2	Base flessibile con attacco ad asta/ Flex din	Tre sistemi di luminosità: rotazione, flash singolo, flash veloce / Pattern: rotation, sigle flash, quick flash	Verde/Green	Certificazioni: CE EMC ECE R65, IP66

LAMPEGGIANTI A LED 12-24V

GYROPHARE A LED 12-24V
2-24V LED BEACONS
DREHLEUCHTE LED 12-24V
FAROS ROTATIVO12-24V

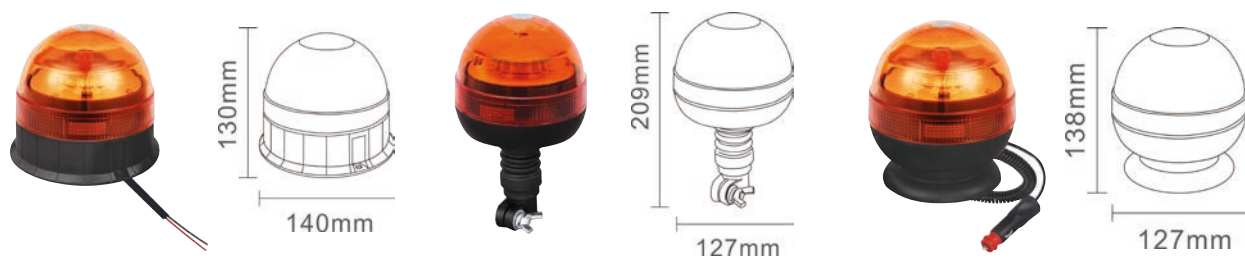

RICAMBI/ SPARE PARTS

Art./Ref.	Descrizione
59113	Calotta ambra serie ATENA
04593	Cavo spiralato con spina agricola ON/OFF

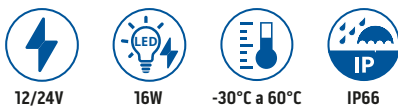

Art./Ref.	Descrizione/Description	Configurazioni/Configurations	Colore/Color	Certificazione/Certification
60116	Base piana/ 3-Bolt fixing	Tre sistemi di luminosità: rotazione, flash singolo, flash veloce / Pattern: rotation, sigle flash, quick flash	Ambra/Amber	Certificazioni: CE EMC ECE R65, IP66
60117	Base flessibile con attacco ad asta/ Flex din	Tre sistemi di luminosità: rotazione, flash singolo, flash veloce / Pattern: rotation, sigle flash, quick flash	Ambra/Amber	Certificazioni: CE EMC ECE R65, IP66
60118	Base magnetica/ Magnetic base	Tre sistemi di luminosità: rotazione, flash singolo, flash veloce / Pattern: rotation, sigle flash, quick flash	Ambra/Amber	Certificazioni: CE EMC ECE R65, IP66

GIROFARI A LED 12-24V CON 7 VARIETA' DI FLASH SELEZIONABILI E SINCRONIZZABILI

GYROPHARES A LEDS 12-24V AVEC 7 MOTIFS FLASH SÉLECTIONNÉS ET SYNCHRONISABLES
 LED BEACONS 12-24V WITH 7 FLASH PATTERNS SELECTED & SYNCHRONIZABLES
 LED-LEUCHTFEUER 12-24V, MIT 7 BLITZMUSTERN AUSGEWÄHLT & SYNCHRONIZIERBAR
 GIROFAROS LED 12-24V CON 7 PATRONES DE FLASH SELECCIONADOS Y SINCRONIZABLES

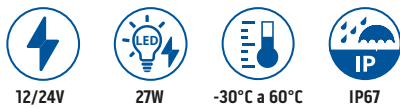

RICAMBI/ SPARE PARTS

Art./Ref.	Descrizione
04597	Spina agricola c/cavo spir on/off e flash

Art./Ref.	Descrizione/Description	Configurazioni/Configurations	Ampere/Ampere	Posizione/Position	Colore/Color	Certificazione/Certification
63120	Base piana Mounting fix	7 modalità di flash: Flash singolo, doppio flash veloce, doppio flash veloce, Flash triplo, Flash quadruplo, Flash mega, Rotazione. Possibilità di sincronizzare i flash di oltre 15 girofari	12V- 7,7A; 24V-0,85A	112x46 mm	Ambra Amber	ECE R10, ECE R65
63121	Base magnetica/ Magnetic base	7 modalità di flash: Flash singolo, doppio flash veloce, doppio flash veloce, Flash triplo, Flash quadruplo, Flash mega, Rotazione.	12V- 7,7A; 24V-0,85A	112x46 mm	Ambra Amber	ECE R10, ECE R65
63122	Base flessibile/ Flexible mount	7 modalità di flash: Flash singolo, doppio flash veloce, doppio flash veloce, Flash triplo, Flash quadruplo, Flash mega, Rotazione.	12V- 7,7A; 24V-0,85A	112x140 mm	Ambra Amber	ECE R10, ECE R65
63129	Base magnetica/ Magnetic base	7 modalità di flash: Flash singolo, doppio flash veloce, doppio flash veloce, Flash triplo, Flash quadruplo, Flash mega, Rotazione.	12V- 7,7A; 24V-0,85A	112x46 mm	Blu Blue	ECE R10, ECE R65

GIROFARI A LED 12-24VV

FEU À ÉCLATS 12-24VV
 LED BEACON 12-24VV
 LED-RUNDUMLEUCHTE 12-24VV
 GIROFARO LED 12-24VV

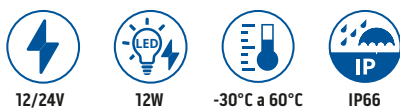
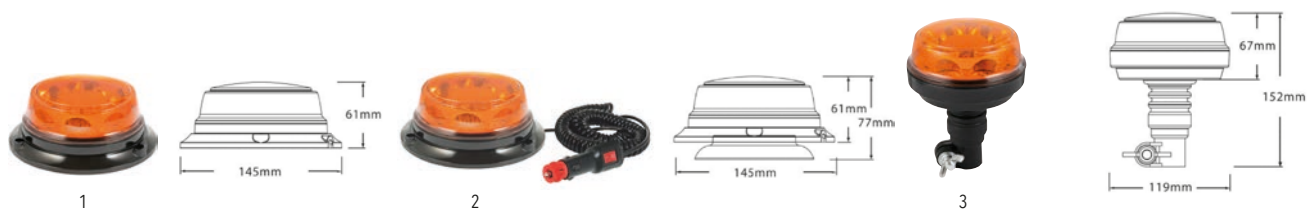

RICAMBI/ SPARE PARTS

Art./Ref.	Descrizione
55404	Calotta ambra 55401/402/403
04593	Cavo spiralato con spina agricola ON/OFF

Art./Ref.	Pos.	Descrizione/Description	Ampere/Ampere	Colore/Color	Configurazioni/Configurations	Certificazione/Certification
55401	1	Base piana/ 3 bolts mount	12V-24V: 0,7A, 0,4A	Ambra Amber	Quattro tipologie di flash: Rotazione, Flash singolo Doppio flash, Triplo (Octa) flash.	ECE R65, ECE R10, CE
55402	2	Base magnetica/ Magnetic	12V-24V: 0,7A, 0,4A	Ambra Amber	Quattro tipologie di flash: Rotazione, Flash singolo Doppio flash, Triplo (Octa) flash.	ECE R65, ECE R10, CE
55403	3	Base imbuto flessibile/ Flexi Din mount	12V-24V: 0,7A, 0,4A	Ambra Amber	Quattro tipologie di flash: Rotazione, Flash singolo Doppio flash, Triplo (Octa) flash.	ECE R65, ECE R10, CE
55415	3	Base flessibile Flexible base	12-24 DC - 0,7-0,4	Verde Green	Quattro tipologie di flash: rotazione, flash singolo, doppio flash, quad flash	R10, CE, RoHS, UKCA
55416	3	Base flessibile Flexible base	12-24 DC - 0,7-0,4	Rosso Red	Quattro tipologie di flash: rotazione, flash singolo, doppio flash, quad flash	R10, CE, RoHS, UKCA

GIROFARI A LED 12-24V

FEUX À ÉCLATS 12-24V
LED BEACONS 12-24V
LED-RUNDUMLEUCHTE 12-24V
GIROFAROS LED 12-24V

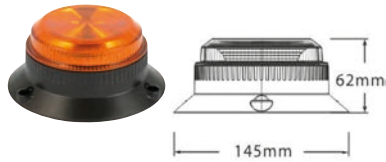

RICAMBI/ SPARE PARTS

Art./Ref.	Descrizione
63123	Calotta ambra per 63117-8-9
04593	Cavo spiralato con spina agricola ON/OFF

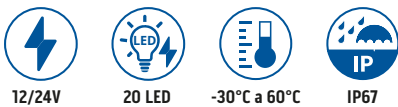

Art./Ref.	Descrizione/Description	Ampere/Ampere	Colore/Color	Configurazioni/Configurations	Certificazione/Certification
63117	Base piana/ 3 bolts mount	12V - 1,6A; 24V - 0,8A	Ambra/Amber	Quattro tipologie di flash: Flash singolo, Doppio flash, Quad flash, Mega flash	ECE R10, ECE R65, EMC, CE
63118	Base magnetica/ Magnetic/	12V - 1,6A; 24V - 0,8A	Ambra/Amber	Quattro tipologie di flash: Flash singolo, Doppio flash, Quad flash, Mega flash	ECE R10, ECE R65, EMC, CE
63119	Base imbuto flessibile/ Pole DIN/Flexi Din mount	12V - 1,6A; 24V - 0,8A	Ambra/Amber	Quattro tipologie di flash: Flash singolo, Doppio flash, Quad flash, Mega flash	ECE R10, ECE R65, EMC, CE

LAMPEGGIANTE LED MINI 9-30V

GYROPHARE A LED MINI 9-30V
MINI WARNING BEACON 9-30V
MINI-WARNBLINKLEUCHTE LED 9-30V
MINI BALIZA GIRATORIA LED 9-30V

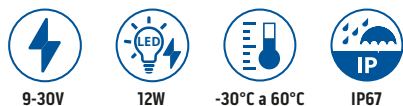
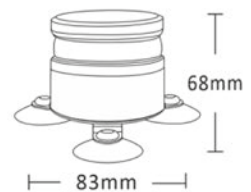
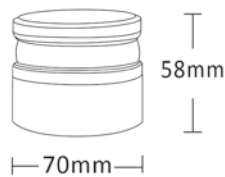

RICAMBI/ SPARE PARTS

Art./Ref.	Descrizione
04597	Spina agricola c/cavo spir on/off e flash

Art./Ref.	Colore/Color	Specifiche/Specifications	Configurazioni/Configurations	Materiale/Material	Note/Notes
68110	Ambra/Amber	Fissaggio con magneti o supporto con ventosa/Magnetic mounting or bracket with suction cup	6 modalità di rotazione/ 6 flash patterns	Base in lega di alluminio, calotta in PC/ Body: aluminium alloy; Len: PC	ECE R10, ECE-R65, IP67, CISPR25 Class 3/

GIROFARI ALOGENI

GYROPHARE

HALOGEN WARNING BEACON

HALOGEN WARNUNG BEACON

FARO ROTATIVO



RICAMBI/ SPARE PARTS

Art./Ref.	Descrizione
63113	Calotta ricambio
08048	Lampada 12 V H1
08049	Lampada 24 V H1
04593	Cavo spiralato con spina agricola ON/OFF

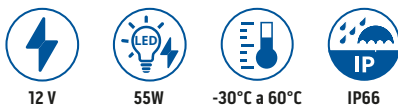

Art./Ref.	Specifiche/Specifications	Colore/Color	Note/Notes	Certificazione/Certification
63110	Base piana/Mounting fix	Ambra/ Amber	Oltre 10000 ore di lavoro	ECE R10, ECE R65
63111	Base magnetica/ Magnetic base	Ambra/ Amber	Oltre 10000 ore di lavoro	ECE R10, ECE R65
63112	Base flessibile/ Flexible mount	Ambra/ Amber	Oltre 10000 ore di lavoro	ECE R10, ECE R65

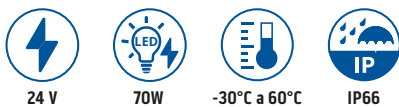

Art./Ref.	Specifiche/Specifications	Colore/Color	Note/Notes	Certificazione/Certification
63110.24V	Base piana/Mounting fix	Ambra/ Amber	Oltre 10000 ore di lavoro	ECE R10, ECE R65
63111.24V	Base magnetica/ Magnetic base	Ambra/ Amber	Oltre 10000 ore di lavoro	ECE R10, ECE R65
63112.24V	Base flessibile/ Flexible mount	Ambra/ Amber	Oltre 10000 ore di lavoro	ECE R10, ECE R65

GIROFARO A LED 12-24V DOPPIA LUMINOSITA'

GYROPHARE LED DOUBLE RANGÉE 12-24V

LED DUAL ROW BEACON 12-24V

LED ZWEIREIHIGE LEUCHTE 12-24V

BALIZA LED DE DOBLE FILA 12-24V



Art./Ref.	Descrizione/Description	Volt/Volt	Watt/Watt	Specifiche/Specifications	Configurazioni/Configurations	Ampere/Ampere	Colore/Color	Materiale/Material	Classe di protezione/Protection class	Temperatura/Temperature	Certificazione/Certification
64495	Base piana	12-24V DC	25W	50 Led	3 modalità flash e 4 modalità di rotazione	12V:2,4A; 24V:1,04A	590-595 nm	Corpo in alluminio, lente e cover in PC	IP67	-40°C a + 60°C	ECE-R65, ECE-R10, SAE J845, IP67, R25-CLASS3, CE, ROHS.
64496	Base magnetica	12-24V DC	25W	50 Led	3 modalità flash e 4 modalità di rotazione	12V:2,4A; 24V:1,04A	590-595 nm	Corpo in alluminio, lente e cover in PC	IP67	-40°C a + 60°C	ECE-R65, ECE-R10, SAE J845, IP67, R25-CLASS3, CE, ROHS.
64497	Base flessibile	12-24V DC	25W	50 Led	3 modalità flash e 4 modalità di rotazione	12V:2,4A; 24V:1,04A	590-595 nm	Corpo in alluminio, lente e cover in PC	IP67	-40°C a + 60°C	ECE-R65, ECE-R10, SAE J845, IP67, R25-CLASS3, CE, ROHS.

LAMPEGGIANTE LED 12-24V

GYROPHARE LED 12-24V
LED BEACON 12-24V
LED LEUCHTE 12-24V
BALIZA LED 12-24V

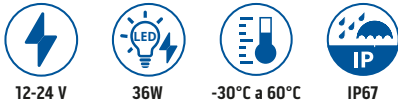
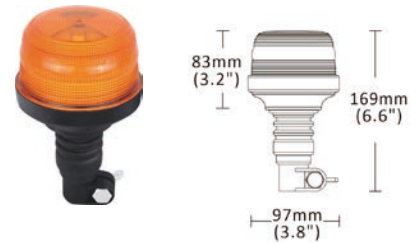
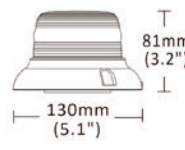
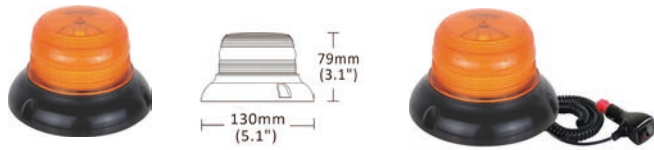

Art./Ref.	Descrizione/Description	Configurazioni/Configurations	Colore/Color	Materiale/Material	Certificazione/Certification
68611	Base piana	Sette tipologie di flash: Flash singolo, Doppio flash, Quad flash, Flash veloce, Rotazione, Rotazione+Quad flash, Flash singolo ICAO	Arancione	PC	ECE-R65, ECE-R10, SAE J845, ICAO, CAP168, UKCA, CE
68612	Base magnetica	Flash singolo, Doppio flash, Quad flash, Flash veloce, Rotazione, Rotazione+Quad flash, Flash singolo ICAO	Arancione	PC	ECE-R65, ECE-R10, SAE J845, ICAO, CAP168, UKCA, CE
68613	Base flessibile	Flash singolo, Doppio flash, Quad flash, Flash veloce, Rotazione, Rotazione+Quad flash, Flash singolo ICAO	Arancione	PC	ECE-R65, ECE-R10, SAE J845, ICAO, CAP168, UKCA, CE

LAMPEGGIANTE LED 10-110V

GYROPHARE LED 10-110V
LED WARNING BEACON 10-110V
DREHLEUCHTE LED 10-110V
LUZ GIRATORIA LED 10-110V

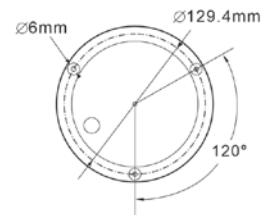
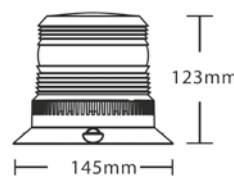

Art./Ref.	Descrizione/Description	Configurazioni/Configurations	Watt/Watt	Ampere/Ampere	Specifiche/Specifications	Materiale/Material
68190	Base piana	Quad Flash	20 LED*0,5W	0,18A-12V 0,07A-24V	Radio protezione CISPR25 classe 3	PC

LAMPEGGIANTE FLASH 10-100V LED

FEU A ECLATS LED 10-100V
LED ROTATING BEACON 10-100V
LED-BLINKLICHT 10-100V
LUZ INTERMITTENTE LED 10-100V

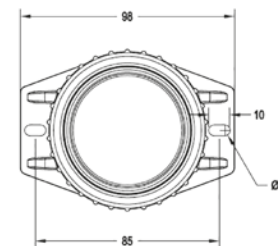
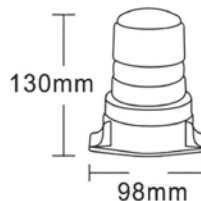

Art./Ref.	Colore/Color	Specifiche/Specifications	Certificazione/Certification
64491	Ambr/Amber	Solo per carrelli elevatori, spazzatrici industriali, piattaforme aeree, piattaforme semoventi per raccolta frutta e altre macchine simili indoor/ The lamp is to be used in indoor transportation using forklifts, industrial sweeping machine, lifting platform or similar machines indoor	R10

LAMPEGGIANTI FLASH 10-100V LED

FEU A ECLATS A BASE PLATE «FLASH»
FLASHING BEACON WITH FLAT BASE "FLASH"
BLITZLEUCHTE MIT GLATTER BASIS „FLASH“
LUCE DE DESTELLOS BASE PLANA "FLASH"

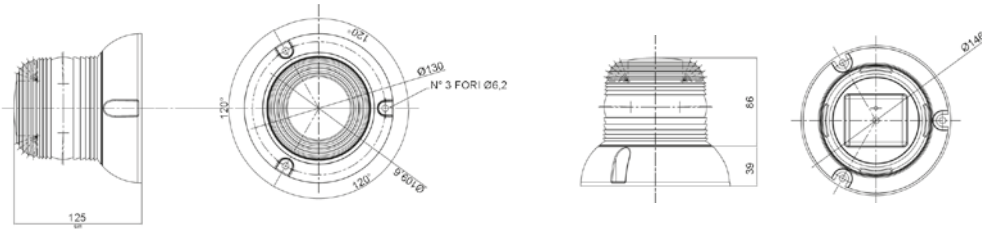

10/100 V

RICAMBI/ SPARE PARTS

Art./Ref.	Colore/Color	Materiale/Material	Note/Notes
L03650	Ambra	Policarbonato	Per girafaro FLASH art. 37814

Art./Ref.	Colore/Color	Configurazioni/Configurations	Specifiche/Specifications	Ampere/Ampere	Materiale/Material	Note/Notes
37814	Ambra/ Amber	Lampada allo Xenon 1J	Frequenza lampeggio: 1,25Hz/100V, 1,00Hz/24V, 0,60Hz/12V;	Massima corrente assorbita: 68,5mA/100V, 37,6mA/24V, 29mA/16V	Base in prolipopilene e calotta in plicarbonato	Per carrelli elevatori e macchine elettriche

LUCI DI SEGNALAZIONE PER EMERGENZA

FEUX DE SIGNALISATION D'URGENCE
EMERGENCY WARNING LIGHT
NOTSIGNALLEUCHTEN
LUCES DE SEÑAL DE EMERGENCIA



3,7V -
750mAh



-30°C a 50°C



IP56



BASE
MAGNETICA



TEMPO
RICARICA
MAX
3,5h



DURATA
BATTERIA
7h

RICAMBI/ SPARE PARTS

Art./Ref.	Descrizione
68133	Luce a ricambio

Art./Ref.	Descrizione/Description	Configurazioni/Configurations	Materiale/Material	Materiale/Material	Led	Accessori/Accessories	Certificazione/Certification
68132	Base magnetica e gancio appendibile	Rotazione, Quad flash, Flash singolo, Flash intermittente, SOS flash, Luce alta continua, Luce bassa continua, Flash 2 LED, Flash 4 LED, Luce da lavoro	PC+gomma in silicone	ABS	16 arancioni, 3 bianchi	2 cavi di ricarica inclusi	CE, ROHS

LUCE DI EMERGENZA A LED

LUMIÈRE D'URGENCE À LED
EMERGENCY WARNING LED LIGHT
LED-NOTLICHT
LUZ DE EMERGENCIA LED

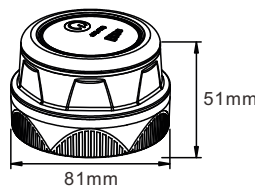

12-24 V DC



IP65



BASE
MAGNETICA



TEMPO
RICARICA
MAX
4h



DURATA
BATTERIA
3-5h



-30°C a 50°C



Battery Status Indicator
Charging port & External Power supply input port
On/Off Switch
Function Switch



Art./Ref.	Descrizione/Description	Configurazioni/Configurations	Base	Materiale/Material	Batteria/Battery	Specifiche/Specifications	Accessori/Accessories	Certificazione/Certification
77006	Base magnetica	28 LED arancioni + 4 led bianchi	ABS	PC	3,7V @ 2200MA	Flash quintuplo (V16), Flash singolo, Flash SOS arancione, Luce bianca	Cavo di ricarica USB 5V input	CE, ROHS, UKCA

LUCI DI SEGNALAZIONE ARANCIO A LED 12/24V

CLIGNOTANT AMBRE' LED 12/24V
 AMBER WARNING FLASH LAMP LED 12/24V
 FAHRTRICHTUNGSBLINKLEUCHTE GELB LED 12/24V
 LUCES DE ADVERTENCIA NARANJA LED 12/24V

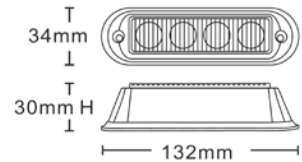
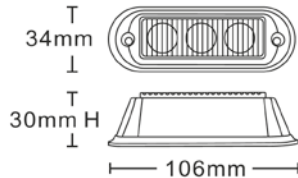

Art./Ref.	Pos.	Led	Descrizione/Description	Colore/Color	Posizione/Position	Dimensioni/Sizes	Note/Notes
64493	1	3	26 varianti di flash con sincronizzazione e funzione di memoria/ 26 flash patterns with synchronization and memory function	Arancio/Amber	IP67	106x34x30 mm	ECE R10, ECE-R65, IP67, CISPR25 Class 3/ECE R10, ECE-R65, IP67, CISPR25 Class 3/ECE R10, ECE-R65, IP67, CISPR25 Class 3/ECE R10, ECE-R65, IP67, CISPR25 Class 3
64494	2	4	26 varianti di flash con sincronizzazione e funzione di memoria/ 26 flash patterns with synchronization and memory function/	Arancio/Amber	IP67	132x34x30 mm	ECE R10, ECE-R65, IP67, CISPR25 Class 3/ECE R10, ECE-R65, IP67, CISPR25 Class 3/ECE R10, ECE-R65, IP67, CISPR25 Class 3/ECE R10, ECE-R65, IP67, CISPR25 Class 3

LUCE DI SEGNALAZIONE FLASH LED ARANCIO 12/24V

AVERTISSEUR FLASH LED 12/24V
 WARNING FLASH LAMP LED 12/24V
 BLITZLEUCHTE LED 12/24V
 LUCES DE ADVERTENCIA 12/24V

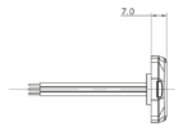
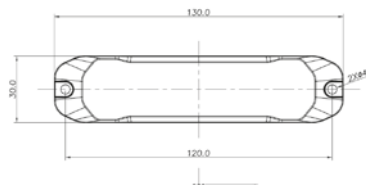
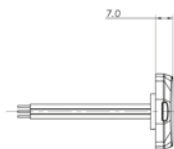
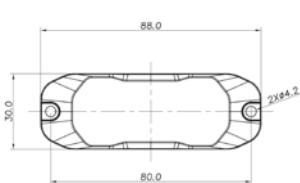

Art./Ref.	Volt/Volt	Colore/Color	Descrizione/Description	Posizione/Position	Watt/Watt	Ampere/Ampere	Classe di protezione/Protection class	Temperatura/Temperature	Materiale/Material	Certificazione/Certification
64468	12-24V DC	Arancio	5 varianti di flash con sincronizzazione e funzione di memoria	Anteriore, posteriore	8W	0,21A a 12V; 0,33A a 24V	IP67	-40°C a + 65°C	Lente in PC; Corpo in alluminio	ECE-R10, ECE-R65, IP67, CISPR 25 Class 3
64469	12-24V DC	Arancio	9 varianti di flash con sincronizzazione e funzione di memoria	Anteriore, posteriore	10W	0,26A a 12V; 0,42A a 24V	IP67	-40°C a + 65°C	Lente in PC; Corpo in alluminio	ECE-R10, ECE-R65, IP67, CISPR 25 Class 3

PIANTONI SUPPORTO PER GIROFARO

SUPPORTS POUR GYROPHARE
 BEACOM FOR REVOLVING LAMPS
 LAGER FÜR RUNDUMLEUCHTE
 SOPORTE PARA FAROL VOLVEANTE

Note: Bipolari
 Notes: Two poles

Art./Ref.	Descrizione estesa/Extended Description	Immagine/Image
55360	Piantone per lampeggiante da saldare	
55361	Piantone di supporto per lampeggiante a vite	
55363	Piantone supporto girofaro con attacco a T	
55365	Piantone supporto girofaro con staffa a L	
55362	Piantone per lampeggiante inclinabile 90°	
76499	Piantone inclinabile bipolare	
55364	Piantone supporto girofaro staffa laterale	
55366	Piantone supporto girofaro inclinabile 180°	
55367	Piantone supporto girofaro con staffa lunga laterale	
0A27231	Piantone girofaro in nylon per art. 0A27232	
0A27232	Supporto per piantone girofaro in nylon	

PRESA BIPOLARE AD INCASSO 6-24V CON CAPPUCCIO

PRISE BIPOLAIRE 6-24V AVEC CAPUCHON
 HANDLAMP SOCKETS 2-PIN WITH COVER
 HANDLAMPEN- STECKDOSEN 2-POLING OHNE DECKEL
 ENCHUFE BIPOLAR C/TAPA

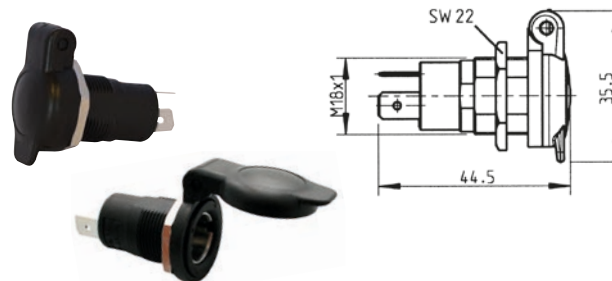

Art./Ref.	Modello/Model	Volt/Volt	Materiale/Material	Dati tecnici/Technical data	Note/Notes
02924	Bipolare	6-24V	Plastica	Connessione a faston 6,3 mm/Connessione a faston 6,3 mm	Con cappuccio/With cover

PRESA BIPOLARE 12-24V IN ALLUMINIO CON COPERCHIO

PRISE BIPOLAIRE 12-24V AVEC CAPUCHON
 HANDLAMP SOCKETS WITH COVER
 HANDLAMPEN- STECKDOSEN 2-POLING OHNE DECKEL
 ENCHUFE BIPOLAR C/TAPA



Art./Ref.	Modello/Model	Volt/Volt	Materiale/Material	Dati tecnici/Technical data	Note/Notes
P19010	Bipolare	6-24V	alluminio	terminali a faston piatto 6,3 mm	Con coperchio

PRESE BIPOLARI IN PLASTICA SENZA CAPPuccio

PRISES DE COURANT BIPOLAIRE SANS CAPUCHON
 2P HANDLAMP SOCKET WITHOUT COVER
 2P HANDLAMPEN STECKDOSE OHNE DECKEL
 TOMA DE CORRIENTE BIPOLAR

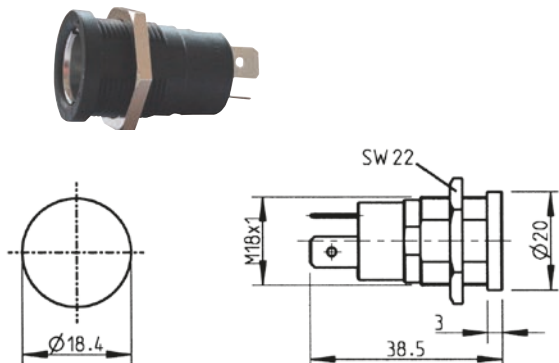

Art./Ref.	Modello/ Model	Volt/ Volt	Materiale/ Material	Dati tecnici/ Technical data	Note/ Notes
02948	Bipolare/ Dual pole	6-24V	Plastica/ Plastic housing	Connessione a faston 6,3 mm	16A

PRESA DI CORRENTE 12V ADATTA PER SPINOTTO

PRISE DE COURANT 12V ADAPTÉE POUR PIN
 POWER OUTLET 12V SUITABLE FOR PIN
 STECKDOSE 12V PIN-GEEIGNET
 TOMA DE CORRIENTE 12V APTO PARA PIN



Art./ Ref.	Volt/ Volt	Dati tecnici/Tech- nical data	Materiale/ Material	Dima mm/ Drilling gauge mm
64473	12V	Portata max 15A	Canotto zoccolo in ferro zincato/ Galvanized iron base plinth	Ø 27,8 mm

CAVO PER GIROFARI

CABLE POUR GYROPHARES
 CABLE FOR REVOLVING LAMPS
 KABEL FÜR RUNDUMLEUCHTE
 CABLE PARA FAROL VOLVEANTE



Art./Ref.	Pos.	Descrizione/Description	Specifiche/Specifications
02590	1	Cavo spiralato con spina	Torciglione 2X0,75 cm, Lunghezza 45 cm
02591	2	Spinotto 2 Vie 5A	Collegamenti interni: perno centrale a saldare e linguetta laterale a faston 6,3
60069	2	Spina per accendisigari	5A, Collegamenti interni: perno centrale con faston 2,8 e linguetta laterale faston 6,3
04590	3	Cavo spiralato con spina accendisigari ON/OFF	Cavo spiralato 0.2mm ² , max lunghezza 3,5 m/Spring cable 0.2mm ² , max length 3,5 m
04592	4	Spina ON/OFF	8A
66009	5	Cavo spiralato con spina accendisigari per girofaro art. 66010 e 66150	Input: DC 12/24V, 1-15A, 12W- 80W; Output: 12V, 1.15A
04597	6	Cavo spiralato con spina ON/ OFF e pulsante per selezionare il flash	Cavo spiralato 0.2mm ² , max lunghezza 3,5 m
04596	7	Adattatore spina accendi sigari	

PRESA 12V 7 POLI CON PRESA 2 POLI SUPPLEMENTARE

DOUILLE 7 POLE 12V AVEC DOUILLE SUPPLEMENTAIRE 2 POLE
7 PIN SOCKET 12V WITH SUPPLEMENTARY 2 PIN SOCKET
7 PIN STECKDOSE 12V MIT ZUSATZLICHER 2 PIN STECKDOSE-
NACH 12V 7 POLE SOCKET CON 2 POLE SOCKET ADICIONALES



Art./Ref.	Modello/Model	Volt/Volt	Dati tecnici/Technical data	Materiale/Material
19038	7 poli + 2 poli supplementari/ 7 pin + 2 pin supplementary	12V	Terminali piatti 6,3x0,8 mm	Plastica/ Plastic housing

SPINA PER ALIMENTAZIONE BATTERIA

ADAPTATEUR SECTEUR
POWER ADAPTER
NETZTEIL
ADAPTADOR DE CORRIENTE



Art./Ref.	Specifiche/Specifications
66008	Input: 100-240V, 50V/60Hz, Max 0,8A; Output: 5.0-12V, Max. 2A, Max 12W

TELECOMANDO PER GIROFARI

TÉLÉCOMMANDE POUR BALISES
PREMOTE CONTROL FOR BEACONS
FERNBEDIENUNG FÜR BAKEN
CONTROL REMOTO PARA BALIZAS



Art./Ref.	Specifiche/Specifications
66149	Telecomando per accendere e spegnere il girofaro e cambiare le modalità di lampeggio.

KIT MAGNETICO

KIT MAGNETIQUE
MAGNETIC KIT
MAGNETISCHER SATZ
KIT MAGNÉTICO



Art./Ref.
03426

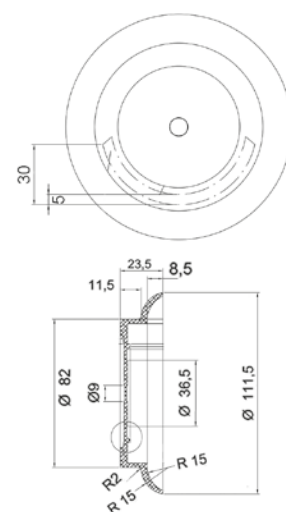

PORTO GIROFARO

PROTECTION POUR GYROPHARE
PROTECTION FOR REVOLVING LAMPS
SCHUTZ FÜR RUNDUMLEUCHTE
PROTECCIÓN PARA FAROL VOLVEANTE



Art./Ref.	Materiale/Material	Specifiche/Specifications
19412	PVC	Funzione anti-smarrimento: il giunto con occhiello permette di fissare il coperchio al piantone



IMEL Division

AMA IMEL DIVISIONE DI AMA S.p.a.
Via G. di Vittorio, 8
41011 Campogalliano (MO) Italy
Tel. +39 0522 6369 (10 linee r.a.) Fax +39 0522 695753
www.ama.it - ama@ama.it

**AMA S.p.A.
Accessori Macchine Agricole**

Via Giacomo Puccini, 28 - 42018 San Martino in Rio (RE) Italy
Tel. +39 0522 636911 - Fax +39 0522 695753
www.ama.it - ama@ama.it

COMPANY WITH
MANAGEMENT SYSTEM
CERTIFIED BY DNV
ISO 9001 • ISO 14001